

## Contents

### Understanding number bonds

Focus 1: To explore number in subsets

Focus 2: Understand the concept of 'whole' and 'parts'

Focus 3: To be able to find number bonds for 'sixteen'

### Preparing for number bonds within 20

Focus 1: To explore number bonds within 10

Focus 2: To consolidate number bonds within 10

Focus 3: To explore place value within 20

Focus 4: To consolidate place value within 20

### Number bonds within 20

Focus 1: To use known number bonds within 10 for finding number bonds within 20

Focus 2: To find out unknown number bonds



**Printable resources can be found at the  
back of the pack.**

# Guidance

## Using the at home materials

This pack contains a series of tasks for you to experience with your child. Each session has been carefully designed to develop number sense and support understanding. Provide lots of opportunities to get children to use mathematical vocabulary and explain their reasoning and reveal their thinking.

We have purposefully selected these short tasks, which should last around 15 minutes, so that you can fit them around your daily lives.

Each session begins with a short adult guided input, followed by a suggested task to complete and a suggested task to explore, which will take their learning deeper.

## Success for all

At school we believe all pupils can achieve success in maths. We encourage pupils to have a belief that effort leads to success and that challenges are opportunities to learn.

Here are a few tips to encourage your children at home with maths:

- ✓Talk to your children about everyday maths
- ✓Play games with them
- ✓Value mistakes as learning opportunities
- ✓Recognise that there is more than one way to work things out
- ✓Praise children for effort over outcome
- ✓Avoid saying things like “I’m useless at maths”

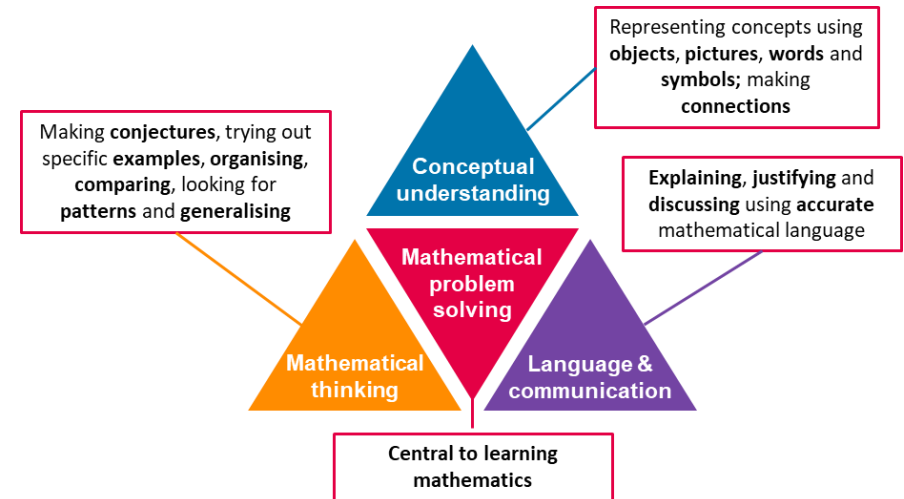

## What is 'Mastery'?

The 'mastery approach' to teaching mathematics is the underlying principle of Mathematics Mastery. Instead of learning mathematical procedures by rote, we want your child to build a deep understanding of concepts which will enable them to apply their learning in different situations. To achieve this we aim to develop pupils' **Conceptual Understanding, Mathematical Thinking and Language and Communication** (see diagram).

## Number Bonds Within 20: Understanding number bonds

Focus 1: To explore number in subsets

### About the maths

Being able to identify the number of objects in sets and subsets is key to developing an understanding of the concept of parts and whole in number bonds.

### Vocabulary

set  
combine

### Resources

Paper, pencils, a range of other objects for sorting that could go together e.g. knives and forks, spoons and bowls etc.

### Getting started

Display a set of squares that have been sorted into two subsets.

Ask pupils to explain how the shapes have been sorted. E.g.

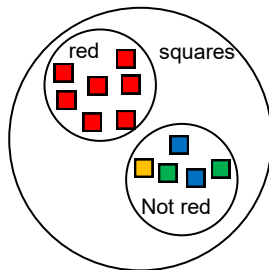

Ask:

How many squares are there in the set?

How many red squares are there in this subset?

How many squares are not red?

### Task for pupils

Provide pupils with shapes that have been sorted into subsets.

Ask pupils to identify how many there are in each subset.

Ask pupils to identify how many there are altogether in the set.

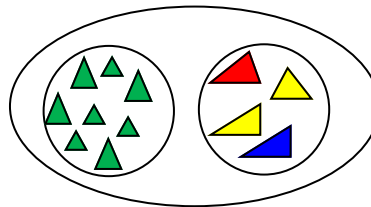

Pupils should be able to identify that:

- there are twelve triangles altogether.
- there are eight green triangles.
- there are four triangles that are not green.

### Deepening understanding

Provide pupils with shapes that have been sorted into more than two subsets.

Ask pupils to identify how many there are in the set and how many there are in each subset.

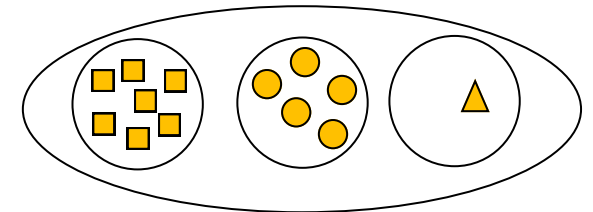

Pupils should be able to identify that:

- there are thirteen orange shapes altogether.
- there are seven orange squares.
- there are five orange circles.
- there is one orange triangle.

## Number Bonds Within 20: Understanding number bonds

Focus 2: To understand the concept of 'whole' and 'parts'

### About the maths

The concept of 'whole' and 'parts' is a key concept to understanding number bonds and is a concept that pupils will apply when learning about different operations.

### Vocabulary

Whole part

### Resources

Coloured shapes

Sorting hoops - you could use skipping ropes or string to create the hoops

### Getting started

Create a set of blue shapes that have been sorted into two subsets.

Ask:

How many blue shapes are there in the set?

How many blue triangles are there in this subset?

How many blue circles are there in this subset?

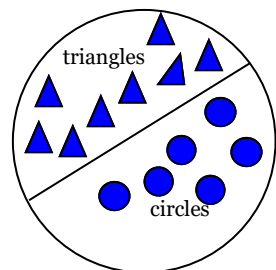

Highlight that the set represents the whole and the subsets represent the parts.

### Task for pupils

Provide pupils with eight green triangles and seven yellow triangles.

Ask pupils to sort the triangles into parts.

Ask pupils to identify how many there are in each part.

Ask pupils to identify how many there are altogether in the whole.

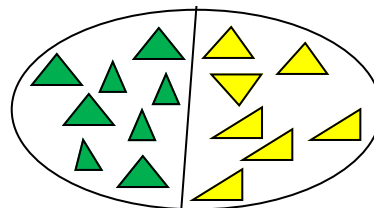

Pupils should be able to identify that:

- The whole is fifteen.
- The parts are eight and seven.

### Deepening understanding

Provide pupils with five triangles that can be sorted to illustrate all number bonds within 5. Model how to place the five triangles in different arrangements so that the parts are different for each example.

Say the whole and the parts for each example.

There are five triangles. There are zero squares. Five is the whole. Five and zero are the parts.

There are five triangles. Four are the same. One is different. Five is the whole. Four and one are the parts.

There are five triangles. There are two green triangles. There are three red triangles. Five is the whole. Two and three are the parts.

## Number Bonds Within 20: Understanding number bonds

Focus 3: To be able to find number bonds for 'sixteen'

### About the maths

For pupils to develop their understanding of number bonds, it is important that they explore number bonds using the same sixteen shapes for the tasks.

### Vocabulary

Set  
Whole, part

### Resources

Shapes, part-whole model

### Getting started

Create a set of sixteen green shapes. Sort the shapes into two subsets.

Ask:

How many green shapes are there in the set?

What is the whole?

How many green triangles are there in this sub set?

How many green circles are there in this subset?

What are the parts?

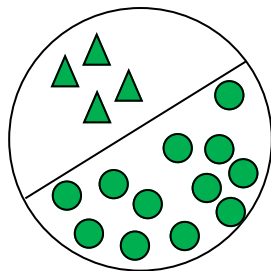

### Task for pupils

Provide pupils with six shapes.

Ask pupils to sort the shapes so that they are in two parts.

For each example, ask pupils to identify the whole and the parts.

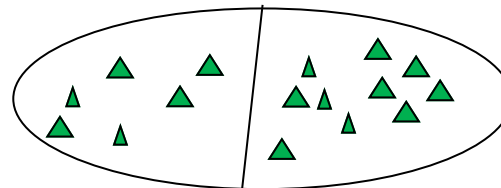

Sixteen is the whole.

Six and ten are the parts.

Ensure pupils find **all** number bonds for 16 (0 and 16, 1 and 15, 2 and 14, 3 and 13, 4 and 12, 5 and 11, 6 and 10, 7 and 9, 8 and 8).

### Deepening understanding

Introduce the part-whole model.

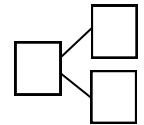

Display one representation of a number bond for sixteen and the part-whole model ask pupils to identify the whole and record it in the model. Ask pupils to identify the parts and record them in the model.

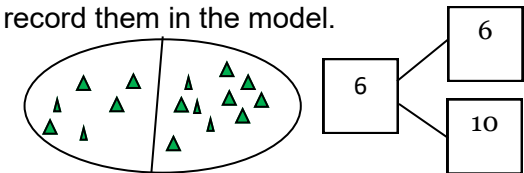

Create a representation for the same number bond for sixteen with the parts on different sides. Discuss what is the same and what is different. Through this discussion pupils should recognise that the whole and the parts are the same but the shapes have been rearranged.

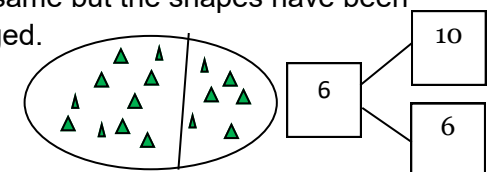

## Number Bonds Within 20: Preparing for number bonds within 20

Focus 1: To explore number bonds within 10

### About the maths

Pupils need a secure understanding of number bonds within 10 before learning number bonds within 20.

### Vocabulary

Rod, colour, equal  
Whole, part

### Resources

Number rods e.g. Cuisenaire ©, Countable objects e.g. buttons, counters  
Part-whole model

### Getting started

These tasks are designed to review number bonds within 10. Pupils who appear to have gaps in their learning about number bonds within 10 may need to focus more on these number bonds within 10 before learning number bonds within 20.

Display 5 countable objects placed into sets to represent the different number bonds for five.

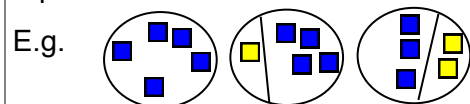

Ask pupils to say how many there are in each set (five) and in each subset.

Place the countable objects from each set in a row.

Emphasise that the whole remains the same (five) and the parts differ in each example. Say what the whole is and what the parts are for each example.

Repeat with number bonds for 4, 3, 2, 1.

### Task for pupils

Provide pupils with the number rod that represents 7 and tell pupils that the number rod represents the whole (seven).

Provide pupils with two rods for each number 0-7)

Ask pupils to find the different pairs of rods that are equal to the whole, ask them to find the two parts that are equal to the whole.

Ensure pupils say what the whole is and what the parts are.

E.g.

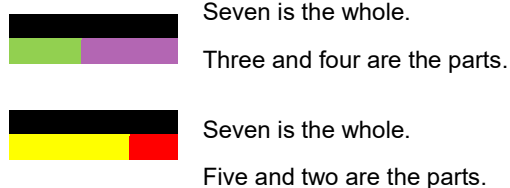

Allow time for pupils to find all possible number bonds for 7 and then 6.

### Deepening understanding

Display an example of a number bond for eight represented using number rods and a part-whole model.

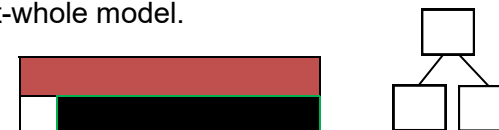

Ask pupils to identify which is the whole and which are the parts.

Ask pupils to record the whole and the parts on the model.

Ask pupils to find all possibilities for 8, then 9 and 10.



If pupils record the same numbers more than once, use it as an opportunity to explore how they represent the same number bond.

## Number Bonds Within 20: Preparing for number bonds within 20

Focus 2: To consolidate number bonds within 10

### About the maths

A secure understanding of number bonds within 10 will support pupils with making connections between number bonds within 10 and within 20.

### Vocabulary

How many  
Whole, part

### Resources

Bead string or other resource with twenty items threaded onto string e.g. pasta tubes, buttons, part-whole model

### Getting started

Display a bead string and a part-whole model.  
Tell pupils that the whole is nine and display nine beads.

Ask pupils to discuss how a bead string could be used to help us to find the parts.

Share suggestions and model how to put the nine beads into two parts.

Record the parts on the part-whole model

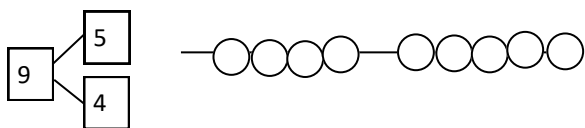

Repeat with all number bonds for 8 and for 10.

### Task for pupils

Ask pupils to find the different number bonds for seven using a bead string.

For each example, pupils should use the same seven beads to reinforce that the whole is the same and that the parts change.

E.g.

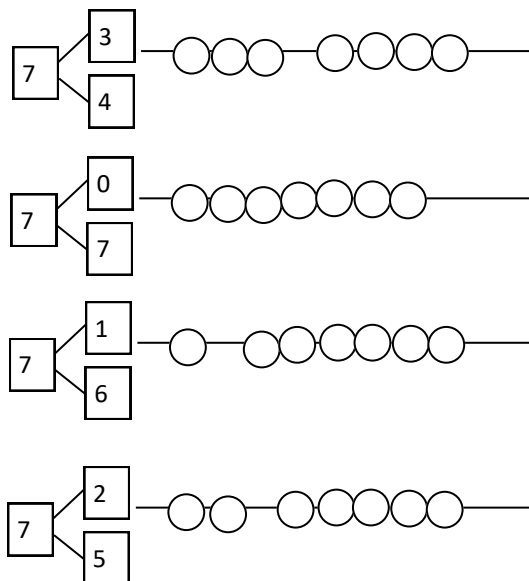

### Deepening understanding

Display a part-part-whole model with the whole and one of the parts recorded.

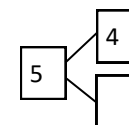

Discuss how the bead string could be used to help us to find out what the missing part is.

Prompts:

What is the whole? Ask pupils to make the represent the whole with the bead string.

What is one of the parts? Ask pupils to move the same number of beads from the whole to represent one part.

How many are there in the other part? Ask pupils to count the beads in the other part.

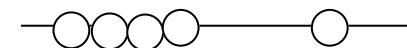

Repeat with any number bond within 10.

## Number Bonds Within 20: Preparing for number bonds within 20

Focus 3: To explore place value within 20

### About the maths

A secure understanding of place value with numbers within 20 will support pupils with making connections between number bonds within 10 and within 20.

### Vocabulary

Group, groups of  
Exchange, regroup  
ones

### Resources

Dienes blocks (20 ones and two tens)

### Getting started

Provide pupils with a tens Dienes (do not tell pupils that is it a ten).

Ask pupils to place the ones Dienes alongside each other to find out how many ones Dienes are equal to a tens Dienes.

Ensure that pupils recognise that ten ones are equal to one ten.

Tell pupils that the longer cuboid is called a ten because it has the same value as ten ones, it is equal to one group of ten.

Tell pupils that the smaller cube is called a one because it has the value of one.

Display 11 ones. Model how to regroup one ten ones for one ten and find out how many ones there are left.

Record it in the table.

11

Tens	ones
1	1

### Task for pupils

Provide pupils with 20 ones and two tens.

Ask pupils to explore grouping 12 ones into tens and exchanging groups of ten for a tens Dienes. Ask pupils to record their answers in a table.

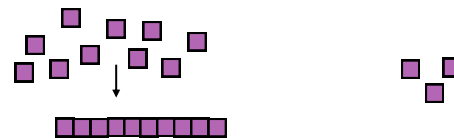

13

tens	ones
1	3

Repeat with numbers 10-20.

### Deepening understanding

Remind pupils that one ten Dienes is equal to ten one Dienes.

Display the table below and explain that they are going to explore numbers within 10.

Provide pupils with nine ones cubes.

Ask pupils to explore whether they can regroup ten ones for one ten and discuss why they can't (because there are not ten ones)

Record the number of tens and the number of ones for nine in a table.

9

tens	ones
0	9

Repeat with all numbers 0-10.



## Number Bonds Within 20: Preparing for number bonds within 20

Focus 4: To consolidate place value within 20

### About the maths

A secure understanding of place value with numbers within 20 will support pupils with making connections between number bonds within 10 and within 20.

### Vocabulary

Group, groups of  
Exchange, regroup  
Tens, ones

### Resources

Dienes blocks (20 ones and two tens)  
Bead string or other resource with twenty items threaded onto string e.g. pasta tubes,

### Getting started

These tasks should be repeated for each pair of numbers (1 and 11, 2 and 12, 3 and 13, 4 and 14, 5 and 15, 6 and 16, 7 and 17, 8 and 18, 9 and 19, 10 and 20)

This example is for 1 and 11.

Provide each pupil with a bead string.

Tell pupils that each bead represents one.

Explain and highlight how the beads on the string have been arranged into groups.

Ask pupils to find out how many beads there are in one group.

Ensure that pupils know the bead string has been grouped into tens.

Ask pupils to show you one bead, ten beads and 11 beads.

Discuss how they know they have the correct number of beads.

### Task for pupils

Provide pupils with partially completed place value charts and ask pupils to find out the missing number.

tens	ones
0	1

Tens	ones
1	1

Ask pupils to explore the numbers represented on the place value chart and discuss how they are the same and how they are different.

Ask pupils to represent the numbers using a bead string and discuss how they are the same and how they are different.

Through this discussion pupils should recognise that 11 has one more ten than 1.

### Deepening understanding

Ask pupils to represent one using Dienes blocks.

Ask pupils to represent 11 using Dienes blocks.

 Allow pupils to count out 11 cubes and regroup ten ones for one ten if necessary to ensure pupils understand that the value of one ten and one one is equal to eleven ones.

Discuss the similarities and differences between the two numbers.

 Ensure that pupils recognise that 11 is ten greater than one.  
Both numbers have one one.  
Eleven has one ten and one doesn't have any tens.

## Number Bonds Within 20: Number bonds within 20

Focus 1: To be able to use known number bonds within 10 for finding number bonds within 20

### About the maths

Links between knowledge of place value within 20, known number bonds within 10 and number bonds within 20 should be made clear to pupils to enable them to find efficient methods for finding number bonds within 20.

### Vocabulary

Dienes, tens, ones  
Bead string  
Whole, part

### Resources

Dienes, Bead string or other resource with twenty items threaded onto string e.g. pasta tubes, buttons.  
Part-whole model

### Getting started

These tasks are designed to be explored by pupils with the following pairs of number bonds (1 and 11, 2 and 12, 3 and 13, 4 and 14, 5 and 15, 6 and 16, 7 and 17, 8 and 18, 9 and 19).

The example for this guide focuses on number bonds for 15.

Display the number 5 and the number 15 and ask pupils to record the number of tens and the number of ones on a place value chart for each number.

Explore what is similar and what is different and ensure that pupils recognise that 15 is ten greater than 5.

Create a representation of a number bonds for 5.

Discuss and explore how we can use our known number bonds for 5 and the knowledge that 15 is ten greater than 5 to find number

### Task for pupils

Ask pupils to create all representations for the number bonds for five.

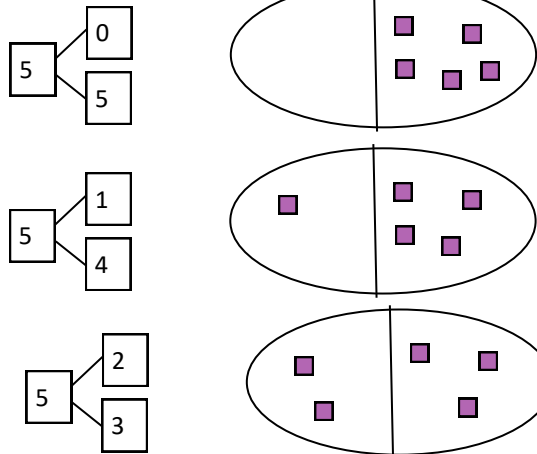

Ask pupils to use the known number bonds and knowledge of place value to find some number bonds for 15 by adding ten to one of the parts.

For each example, make sure pupils use the same Dienes.

### Deepening understanding

Display an example of a number bond for five and two number bonds for 15 with the whole and one of the parts completed. Make sure the part shown is a part for a number bond for five.

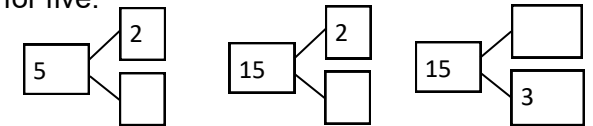

Ask pupils to identify what is known (the whole and one of the parts) and what is unknown (one of the parts).

Ask pupils to refer to their known number bonds for five and identify what the other part would be if five is the whole.

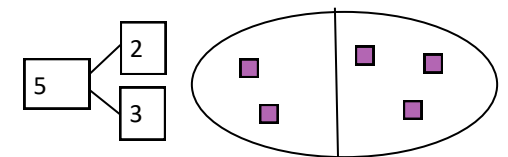

**Number Bonds Within 20: Number bonds within 20**

Focus 1: To be able to use known number bonds within 10 for finding number bonds within 20

...continued

**Getting started**

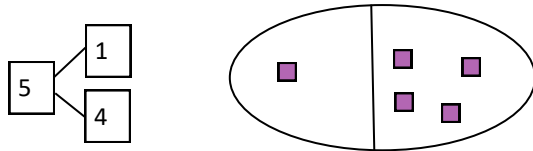

Five is the whole. One and four are the parts.

Fifteen is ten greater than five.

If we make one of the parts ten greater then the whole will be fifteen.

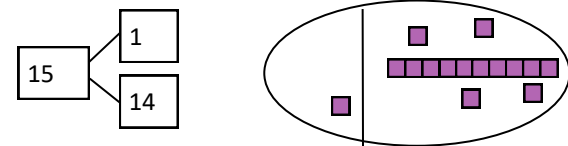
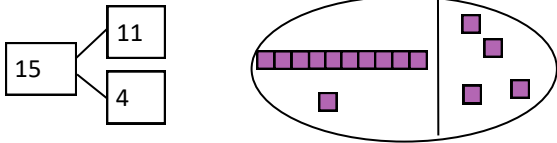

When exploring the number bonds, use the same Dienes to show that the whole remains the same.

For each number bond make links between the number bond for 5 and that 15 is ten greater than 5.

**Task for pupils**

E.g.

Five is the whole. Zero and five are the parts.

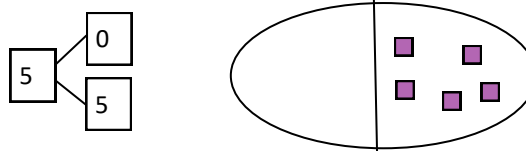

Fifteen is ten greater than five. If I add ten to one of the parts, the whole will be fifteen.

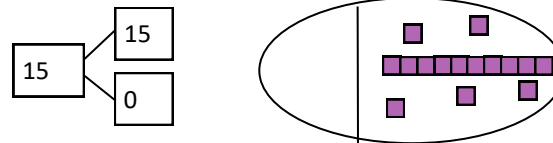
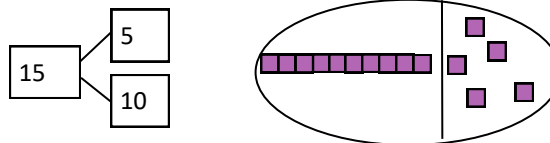

Ensure pupils find all number bonds they can using known number bonds for five and place value.

**Deepening understanding**

Ask pupils to refer to their knowledge of place value and knowledge of number bonds for five and identify what the other part would be if fifteen is the whole.

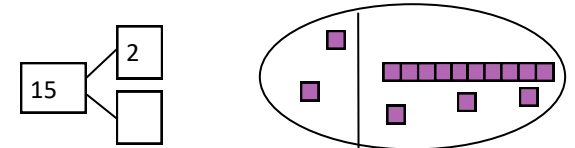

Ask pupils to refer to their knowledge of place value and knowledge of number bonds for five and identify what the other part would be if fifteen is the whole.

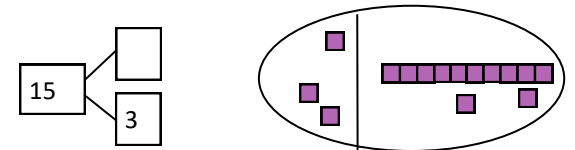

Continue to make links between number bonds within 10 and number bonds within 20.

## Number Bonds Within 20: Number bonds within 20

Focus 2: To be able to find out unknown number bonds

### About the maths

Pupils understanding of number bonds will develop through exploring number bonds in a variety of ways. References should be made to the 'whole' and the 'parts' throughout these tasks.

### Vocabulary

How many  
Whole, part

### Resources

Bead string or other resource with twenty items threaded onto string e.g. pasta tubes, buttons.

Part-whole model

### Getting started

These tasks are designed to be explored by pupils for each number 11-20.

The example for this guide focuses on number bonds for 15.

Display a bead string and a part-part-whole model.

Tell pupils that the whole is fifteen and display eight beads.

Ask pupils to discuss how a bead string could be used to help us find the parts.

Share suggestions and model how to put the eight beads into two parts.

Record the parts on the part-part-whole model

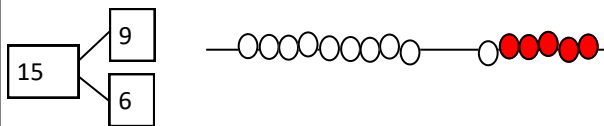

### Task for pupils

Ask pupils to find the different number bonds for fifteen using a bead string.

For each example, pupils should use the same fifteen beads to reinforce that the whole is the same and that the parts change.

For each example, pupils should be encouraged to use a systematic approach to reinforce that, when one part decreases by one, the other part increases by one when the whole is the same.

E.g.

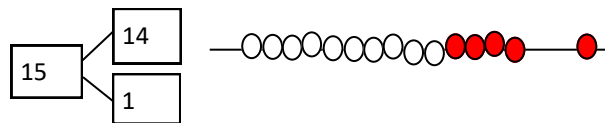
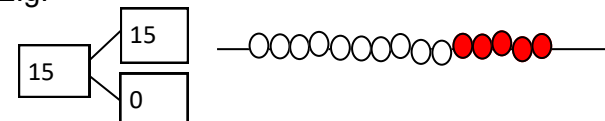

### Deepening understanding

Display a part-whole model with the whole and one of the parts recorded.

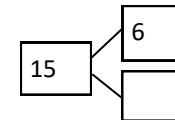

Discuss how the bead string could be used to help us to find out what the missing part is.

Prompts:

What is the whole? Ask pupils to represent the whole with the bead string.

What is one of the parts? Ask pupils to move the same number of beads from the whole to represent one part.

How many are there in the other part? Ask pupils to count the beads in the other part.

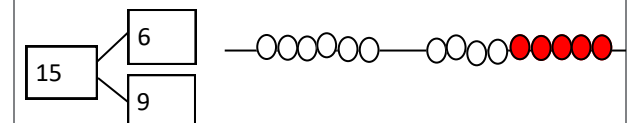

## Number Bonds Within 20: Number bonds within 20

Focus 2: To be able to find out unknown number bonds

...continued

### Getting started

Starting with the whole as one of the parts, display the part-part-whole model with the whole and one of the parts shown. Show representation of the whole and the parts using a bead string.

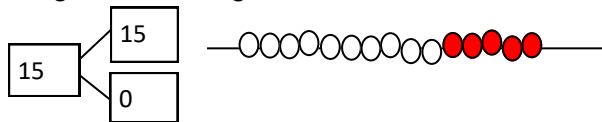

Ask pupils to use the bead string to find out what the missing part is.

Move one bead from the part to show a different number bond. Ask pupils to discuss how each part has changed.

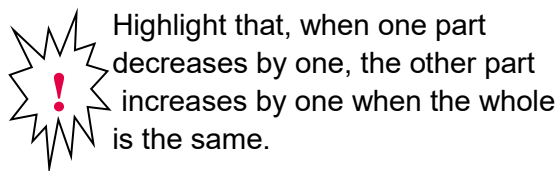

Repeat with another example using a systematic approach. Each time highlighting that when one part decreases by one, the other part increases by one when the whole remains the same.

### Task for pupils

15	13	2	
15	12	3	
15	11	4	
15	10	5	
15	9	6	
15	8	7	

Ask pupils to continue to ensure that they have got all of the number bonds for the whole.

Once pupils have found all of the number bonds, ask pupils to identify the ones that they could have found using place value and

### Deepening understanding

Repeat with other examples for number bonds for 15.

When appropriate, make explicit links between the number bonds for 5 and place value.

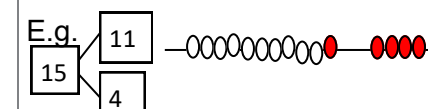

5 is the whole, 1 and 4 are the parts.

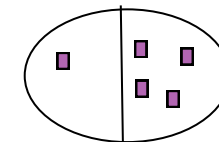
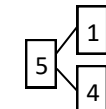

15 is ten greater than 5.

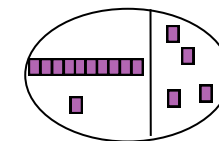
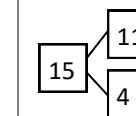

I can add ten to the part that is one. The whole is now 15. the parts are 11 and 4.

When appropriate, make explicit links between the approach used in the tasks for this session.

E.g.

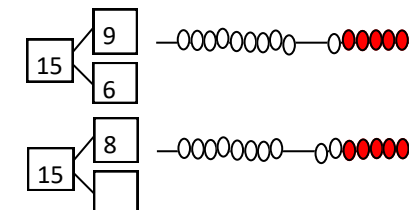



Coloured 2-D shapes - ensure to cut out the squares and not the individual shapes.

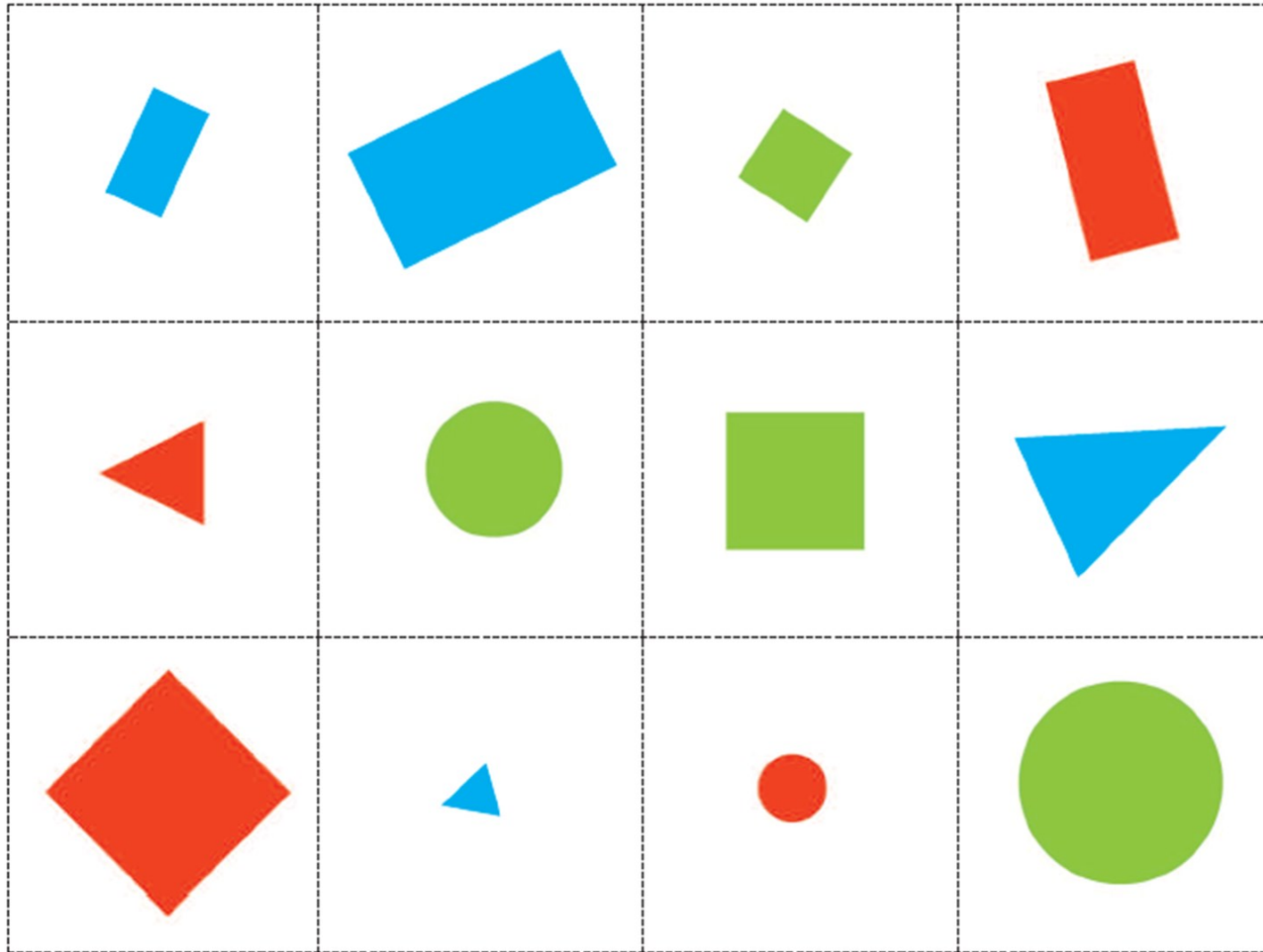





20 Counters

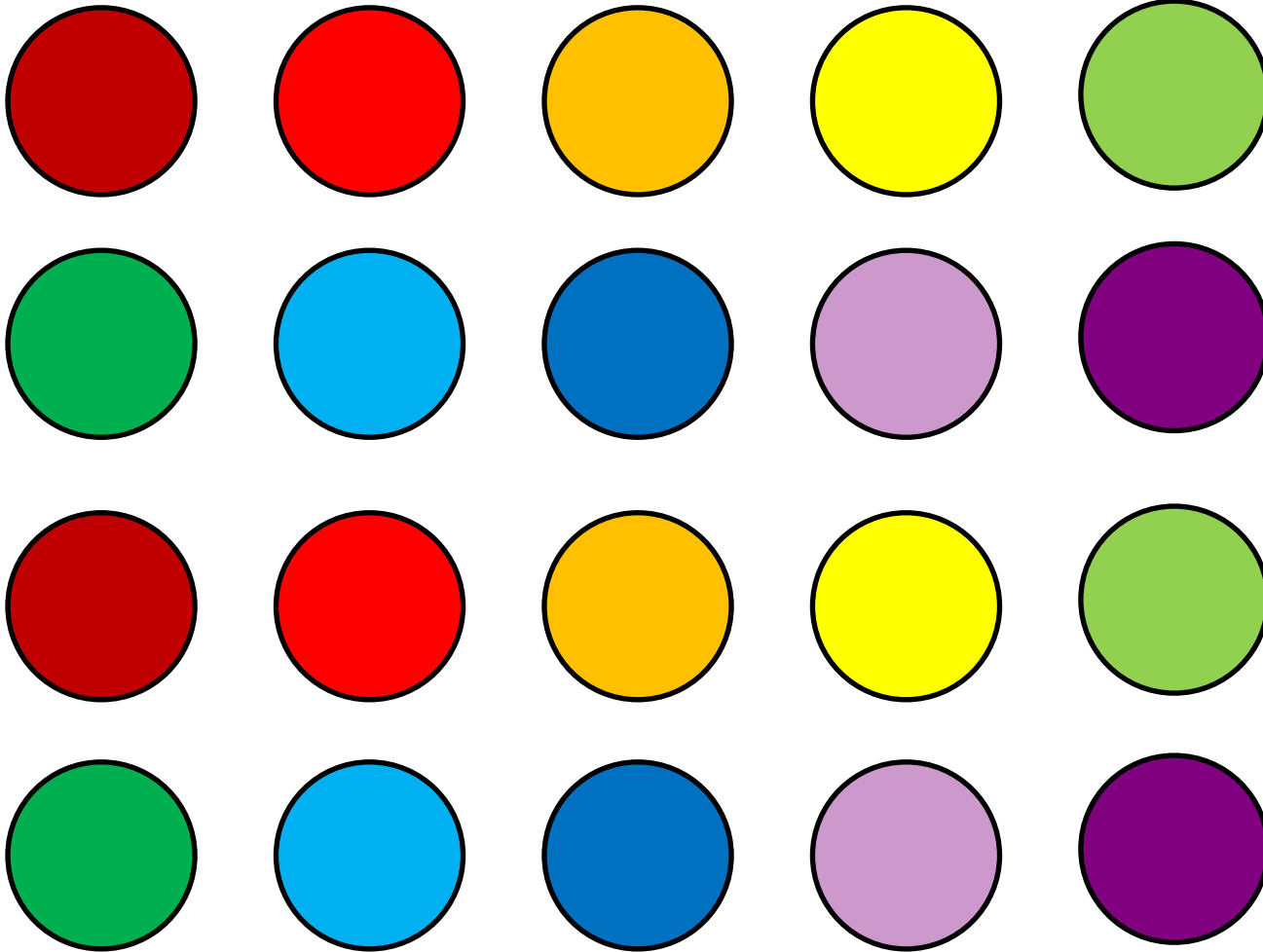



Part-whole model

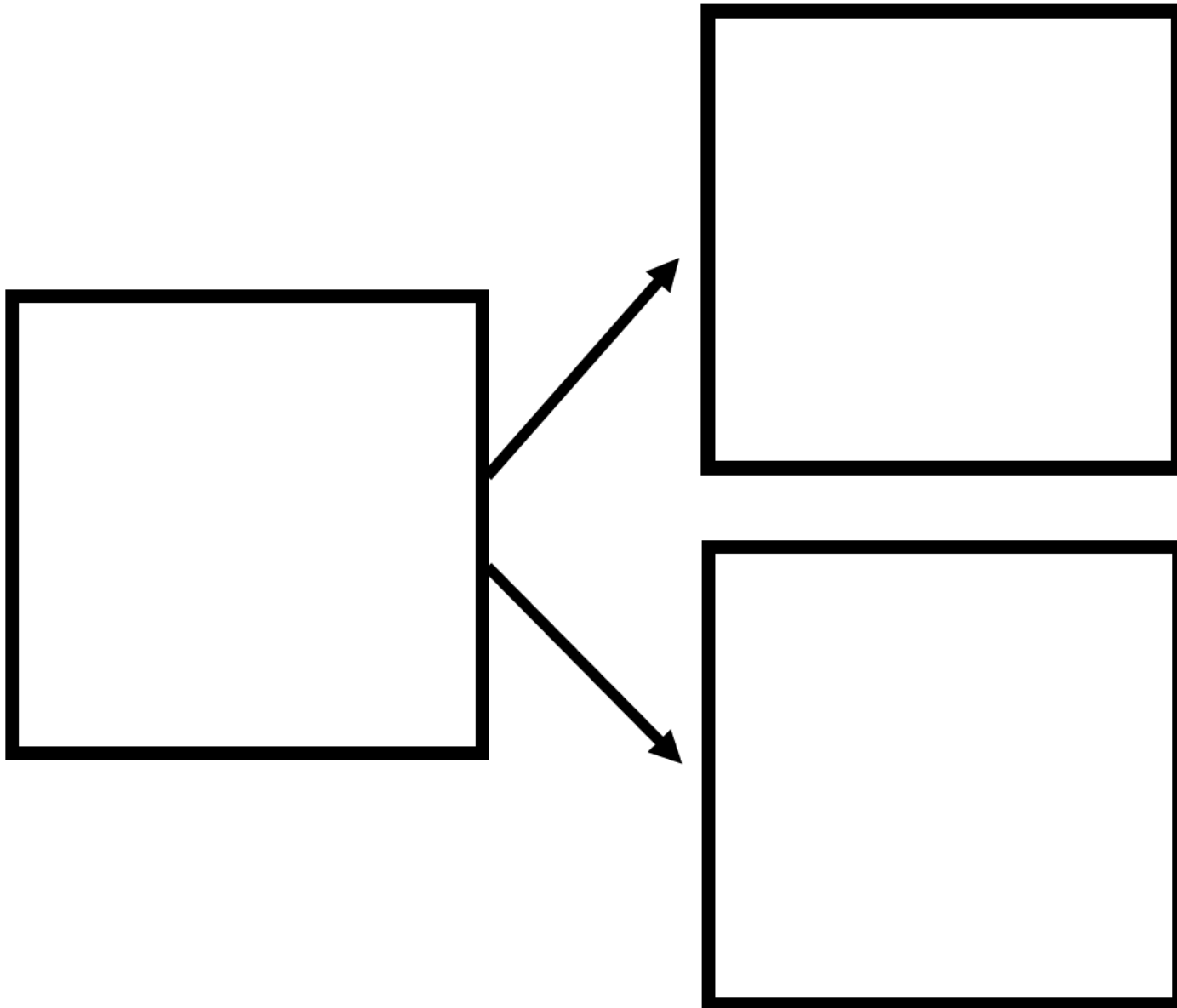



# Cuisenaire Rods

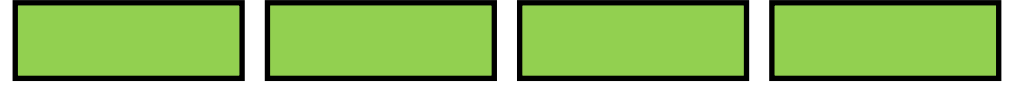
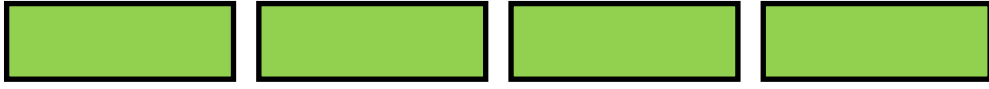
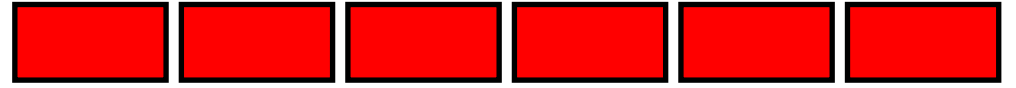
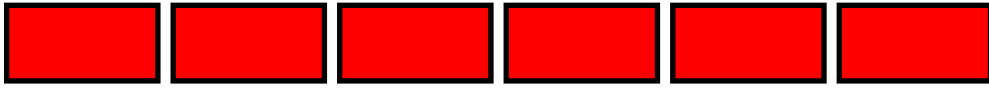
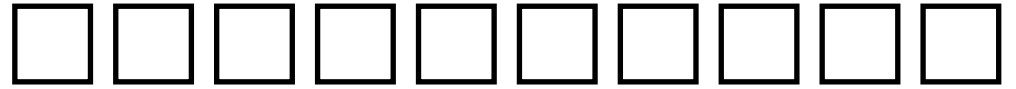
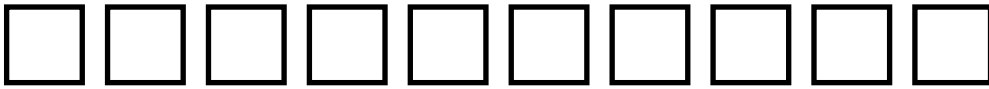



Dienes

